



i-team®





INSTRUCTION MANUAL

i-mop XXL

230/240/115 Volt



Model Number:
IMOPXXL.FCT.1107C
IMOPXXL.FCT.1207C
IMOPXXL.FCT.1307C
IMOPXXL.FCT.2507C

	 <p>The device is only suitable for indoor use; do not expose the device to rain.</p>	 <p>Read these instructions before using the i-mop</p>	 <p>Read these Safety Instructions before operating.</p>	 <p>WARNING: Strong Magnets.</p>
---	--	---	---	--

THANK YOU FOR CHOOSING THE i-mop

Please read this manual carefully for important safety information and operating instructions before using the i-mop. Keep this manual for future reference because it contains important information.

This i-mop will provide excellent performance, but the best results will be obtained if the i-mop is:

- Regularly maintained per the i-mop preventative maintenance instructions provided.
- Operated with reasonable care and caution.
- Maintained with manufacturer-supplied parts.

TABLE OF CONTENTS

P. 03 Product Description	P. 14 Switching Off/Completing Cleaning
P. 03 Function	P. 14 Emptying Tank
P. 03 Safety Instructions – i-mop XXL	P. 14 Removing Battery Packs
P. 04 Safety Instructions – i-mop XXL	P. 15 Transporting/Moving Inside a Building
P. 05 Safety Instructions – Battery Packs	P. 15 Transporting/Moving Outside of a Building
P. 06 Safety Instructions – Battery Charger	P. 15 Transport the i-mop in a Car
P. 07 Unpacking	P. 15 Storing the i-mop
P. 07 Contents	P. 16 Maintenance and Care
P. 08 Initial Setup	P. 16 After Each Use
P. 09 Charging Battery Packs	P. 16 Weekly
P. 10 Installing Brushes	P. 16 Accessories/Spare Parts
P. 10 Installing Squeegee	P. 16 How to Replace the Brushes
P. 11 Installing Solution Tank	P. 17 How to Replace the Squeegee
P. 11 Installing Recovery Tank	P. 17 How to Switch/Replace Squeegee Blades
P. 11 Installing Battery Packs	P. 17 How to Replace the Vacuum Hose
P. 12 Operation	P. 17 How to Reset the i-mop
P. 12 Filling the Solution Tank	P. 18 Troubleshooting and Service
P. 12 Recovery Tank	P. 18 Technical Data
P. 12 Setting the i-mop in “Operating Position”	P. 18 Accessories and Spare Parts
P. 13 Selecting the Mode of Operation	P. 19 Environmental Protection
P. 13 ECO (Water Saving Mode)	P. 19 CE Declaration
P. 13 Battery Packs Status Indicator	P. 19 Warranty
P. 13 Controlling the i-mop	P. 20 Exploded View



1. Operating Panel
2. Trigger
3. Handle
4. Solution Tank
5. Recovery Tank
6. Scrub Deck

SAFETY INSTRUCTIONS – i-mop XXL

GENERAL PRECAUTIONS

Your safety, and that of others, is very important. Operating this i-mop safely is an important responsibility. In addition to the information contained in this Instruction Manual, all statutory safety and accident prevention regulations must be observed.

Do not operate this i-mop unless:

- You are trained and authorized to do so.
- You have read and understand this Instruction Manual.

When operating this i-mop:

- Remove loose objects from the floor that could be accidentally propelled by the rotating brushes.
- Keep your hands and feet away from the rotating brushes.
- Never operate the i-mop near flammable dusts, liquids or vapors. Never use a flammable solvent as a cleaning agent.
- Never operate the i-mop when flammable or poisonous liquids like gasoline, oil, acids, or other volatile substances are on the floor
- Use caution when maneuvering.
- Dress safely. Do not wear a necktie, scarf, or any loose or dangling clothing or jewelry while operating this i-mop because they can tangle in rotating parts, causing serious injury or death.

Before leaving the i-mop:

- Turn the i-mop off.
- Park the i-mop on a level surface (in the "Park" position).
- Empty and rinse Recovery Tank
- WEEKEND STORAGE: Battery packs should be removed from the machine when not in use for more than 2 days to prevent damage to the battery's life cycle from self-discharge.

Before servicing the i-mop

- Disconnect the battery packs.
- Do not wear rings or metal wristwatches when servicing this i-mop because they can cause an electrical short circuit, which can cause serious burns.

PRODUCT DESCRIPTION:

Model Number:

- IMOPXXL.FCT.1107C EUROPE
- IMOPXXL.FCT.1207C UNITED KINGDOM
- IMOPXXL.FCT.1307C SWITZERLAND
- IMOPXXL.FCT.2507C 115 VOLT

FUNCTION

The i-mop XXL is an auto scrubber which is used for cleaning hard floors. A working width of 62cm (24.4") and the nearly unrestricted pivot technology enable an effective cleaning of small or medium spaces. Snap-on components, including the 5L (1.25 gallon) Solution Tank and the 8L (2 gallon) Recovery Tank, in combination with rechargeable battery packs allow 24/7 operation (based on switching out batteries in 60 minute work/recharge cycles).



DANGER

Flammable materials can cause an explosion or fire. Do not use flammable materials in tanks.



WARNING

- Do not use water that exceeds 45°C / 113°F. Using water above this temperature, will void the Tank Warranty.
- Do not use cleaning solution with pH below 3 or above 11 in order to prevent damage to sensitive components like hoses and valves.
- Do not park this i-mop on ramps or slopes. Always park this i-mop on a level, hard surface. Do not operate this i-mop outdoors or on uneven surfaces.
- To avoid electrical shock, do not operate this i-mop over electrical floor outlets.



CAUTION

- Do not remove, paint over or destroy warning decals.
- Always turn off this i-mop before leaving it unattended.
- Do not allow untrained persons to operate this i-mop.
- NO RIDERS. Do not carry passengers on this i-mop. Do not use this i-mop as a stepladder or work platform.
- To avoid damage to this i-mop, use only cleaning solutions and replacement parts recommended by the manufacturer.
- Do not operate this i-mop if any parts have been damaged or removed.
- Always use the automatic Battery Charger provided by the manufacturer of the i-mop to charge the battery packs.
- To avoid damage to the electronic control components of the i-mop, do not store outdoors.
- Do not pressure wash the i-mop.
- This product contains strong magnets. The ingestion of magnets can result in intestinal damage, causing serious injury or death. Use extreme care when handling magnets. Seek immediate medical attention if magnets are ingested into the body.
- The magnets in this product have the potential to disrupt electronic devices. Before putting magnets in contact with any other electronic devices, please research your specific devices. Magnets may interfere with the operation of pacemakers and implantable cardioverter-defibrillators. People with these devices or other electronic medical devices should not use this product.
- Keep away from children. Please note that the i-mop is sold as a commercial cleaning machine for trained and authorized adults and is not a children's toy.

SAFETY INSTRUCTIONS – BATTERY PACKS

GENERAL PRECAUTIONS

Read all the warnings before using the i-mop battery packs.

- The battery packs are equipped with electronic thermal protection. Refer to the Temperature Range Table below for recommended operating conditions.
- Always keep the battery packs clean and dry.
- Do not store battery packs along with metal objects due to risk of short circuit.
- Do not work with near open flames, sparks, or smoke in the vicinity of a battery pack or a Battery Charger area due to danger of explosion.
- The i-mop uses Lithium-Ion (Li-Ion) batteries. Used battery packs are to be disposed of according to the appropriate government regulations in an environmentally-friendly manner.
- Do not crush.
- Do not dismantle.
- Do not heat or incinerate the battery packs.
- Do not short circuit the battery packs.
- Do not immerse in any liquid.
- Do not charge in temperatures below 0°C / 32°F.

TECHNICAL DATA	
CHARGING	5°C ~ 40°C / 41°F ~ 104°F
DISCHARGING	5°C ~ 45°C / 41°F ~ 113°F
STORAGE	
< 1 MONTH	5°C ~ 40°C / 41°F ~ 104°F
< 6 MONTH	5°C ~ 35°C / 41°F ~ 95°F

- Do not charge damaged battery packs.
- Do not leave the battery packs in a discharged state; recharge them as soon as possible.
- Use only original i-mop battery packs, when replacement batteries are required.
- The batteries should not be stored or charged in direct sunlight.
- The batteries should not be charged in an unventilated area where the temperature exceeds 30°C / 86°F.



WARNING

The battery packs included with the i-mop must only be charged by the i-mop Battery Charger supplied with the product and in NO circumstances should an alternative charger be used because there is a risk of severe damage, and fire could result.

HEALTH HAZARDS

- The chemicals used in the battery packs are in a sealed container.
- A damaged or leaking battery pack can cause chemical burns upon contact.
- Risk of battery chemical exposure only occurs if the battery pack is abused or damaged.
- Contact of electrolyte and lithium with skin and eyes should be avoided.
- If the battery packs are leaking, dispose of them in an appropriate manner.
- The battery packs must be removed from the i-mop before the i-mop is retired.



WARNING

FIRST AID MEASURES

If exposed to any of the battery chemicals, please follow the procedures below:

Eyes

- Flush eyes with plenty of water for at least 15 minutes, occasionally lifting the upper and lower eyelid.
- Seek medical attention.

Inhalation

- Vacate from site of exposure to fresh air immediately. Use oxygen if available.
- Seek medical attention.

Ingestion

- Give at least two glasses of milk or water. Induce vomiting unless patient is unconscious.
- Seek medical attention.

SAFETY INSTRUCTIONS – BATTERY CHARGER

GENERAL PRECAUTIONS

Read all these warnings before using the Battery Charger.



CAUTION

- Charge only original i-mop Lithium-Ion (Li-Ion) battery packs – other types of batteries may burst causing personal injury and damage.
- Check the power cord regularly for any sign of damage.
- Do not use the charger in a closed cabinet. Use only in a ventilated space.
- Do not use a damaged Battery Charger.
- If the power cord of the charger is damaged, it must be replaced by a manufacturer-supplied Battery Charger cord.
- Protect the Battery Charger against moisture and store in a dry place.
- The device is only suitable for indoor use. Do not use it outdoors.
- Do not use the Battery Charger if it is wet.
- Do not expose the Battery Charger to rain.
- Do not charge in temperatures below 0°C / 32°F.
- The main voltage available must correspond to the voltage stated on the rating plate of the Battery Charger.
- Do not operate the Battery Charger in an explosive environment.
- Do not carry the Battery Charger by holding the power cord.
- Do not handle the electrical cord or plug it into an outlet if hands are wet.
- Do not unplug by pulling on cord. To unplug, grasp the plug, not the cord.
- Do not cover the Battery Charger while in use.
- Do not open the Battery Charger. Repairs should be done only by manufacturer-authorized personnel.
- Do not charge damaged battery packs.
- Do not charge the battery packs if they are wet – charge dry battery packs only.
- Do not charge non-rechargeable battery packs in this Battery Charger.
- Do not leave batteries on Battery Charger. Remove when fully charged to avoid self-discharge.







UNPACKING

Place the box in a horizontal position on the floor, keeping enough space around you to work. Carefully cut along the top opening with a cutter. Remove the foam packing covering the i-mop and take out the boxes. Pull up the handle (90°), while grabbing the scrub deck. Squat down properly to avoid strain before lifting the i-mop. Place the i-mop on the floor in the "Park" position.

CONTENTS

Please make sure no items are missing by checking the contents against the above list. If one of the parts listed is missing, please contact your i-mop dealer.

	1 x i-mop XXL		1 x Battery Pack (left)		1 x Power Cord
			1 x Battery Pack (right)		1 x Squeegee Assembly
	1 x Solution Tank		1 x Battery Charger		2 x Brushes (medium)
	1 x Recovery Tank		1 set Splash Guard		1 x Manual

INITIAL SETUP

Set the i-mop in the "Park" position.

For the initial setup or anytime the squeegee is not installed: pull the hose back up from the top while guiding the lower half back into the i-mop to make sure the vacuum hose will not be crimped during the following procedure.

Move the upper body of the i-mop into the upright vertical position.

Crouch down and while holding the handle with one hand; hold the scrub deck with your other hand.

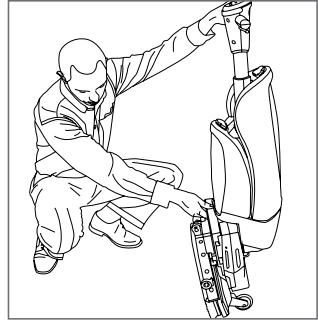
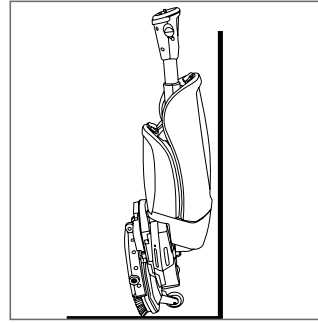

Lift up the scrub deck slowly until it's standing upright on the front wheels; guide the body towards the scrub deck until it snaps into a resting position.

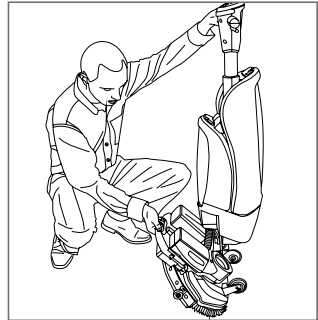

Please ensure that the i-mop is parked in a place where nobody can bump into it. We recommend always parking the i-mop close to a wall with the handle pointing towards the wall and the brushes facing away from the wall. This will ensure that the i-mop leans against the wall if it is bumped.

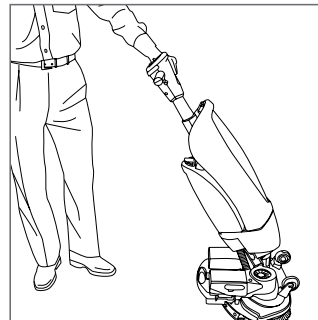

CHARGING BATTERY PACKS

You must charge the battery packs for at least 5 hours before you use the i-mop for the first time. Plug the supplied power cord into the charging dock before plugging it into an outlet.

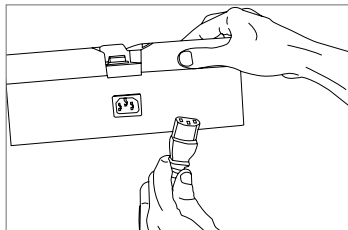

Align the specified battery packs with the charging dock and slide each battery pack in from the side until you hear a click. The battery packs are now fixed in position and ready for charging.

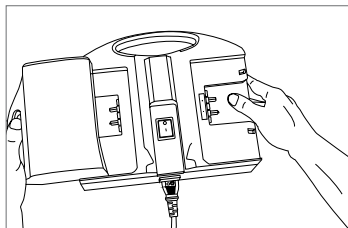

Turn on the Battery Charger on by pressing the switch; the switch should light up to indicate the power is on, and the battery packs are now charging, which is indicated with an LED (red – charging/ green – fully charged). It takes approximately 5 hours to fully charge an empty set of battery packs.

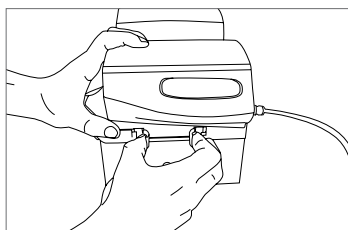

When the battery packs are charged, press the plastic tabs (blue or grey) on the battery packs together and slide them out of the charging dock.

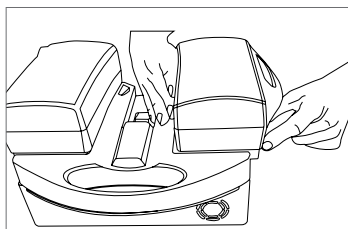

Red LED

When the battery pack is charging, the red LED glows.

Green LED

When the battery pack is fully charged, the green LED glows. When fully charged, remove the battery packs of the Battery Charger and switch off the Battery Charger.

ATTENTION:

If the i-mop isn't used regularly, store the charged battery packs in a dry, clean place. Make sure the battery packs are charged monthly, even when not in use.

INSTALLING BRUSHES

With the I-mop in the "Park" position, hold the scrub deck with one hand while using your other hand to align the brush with the motor disc. Look for and align the latches and cut-outs in the brush and motor disc. Turn the left brush clockwise and the right brush counterclockwise, until you see the motor disc turning to lock the brushes in place.

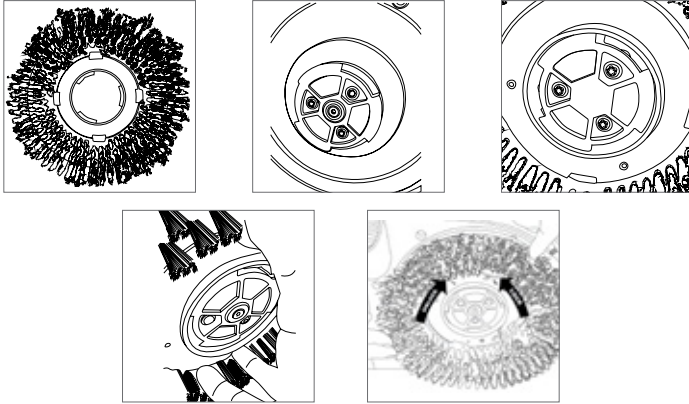

INSTALLING SQUEEGEE

Take the vacuum hose at the scrub deck of the i-mop and insert it into the hose connector on the squeegee. Connect them by twisting the hose 1/4 turn or until they have lined up. Pull the hose back up from the top while guiding the lower half back into the i-mop. Hold the scrub deck of the i-mop with one hand while pushing the left side of the squeegee in place. Switch hands afterwards and repeat for the right side of the squeegee.

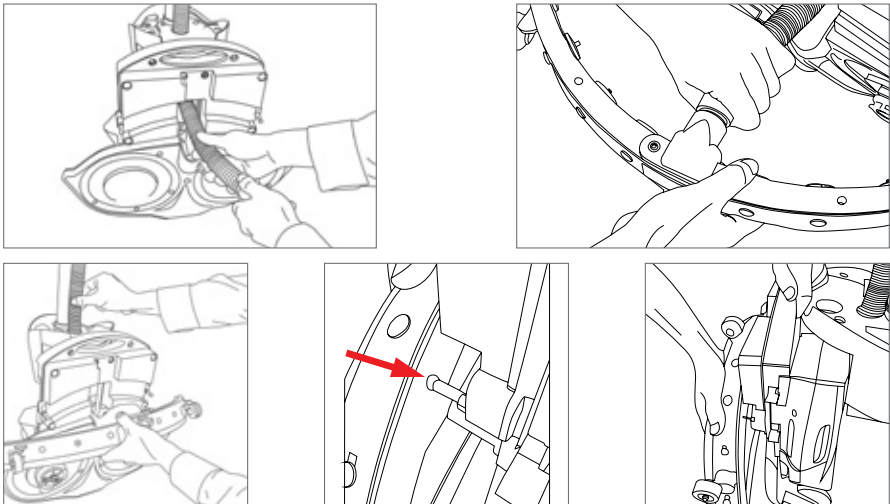

INSTALLING SOLUTION TANK

Fill the small tank with no more than 5L (1.25 gallon) of clean water or appropriate non-foaming detergent. Put the tank on the i-mop with the valve first. Press the tank downward to break the seal of the valve.

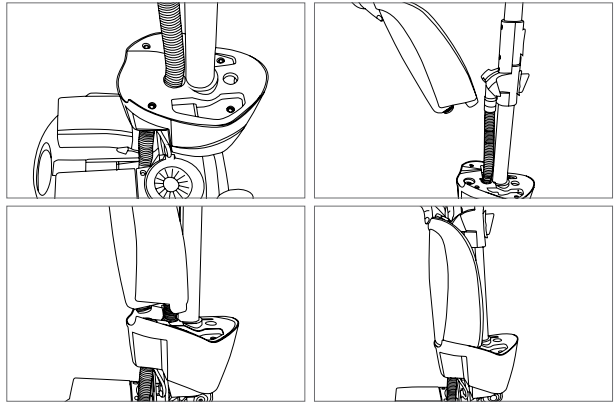

INSTALLING RECOVERY TANK

Put the bottom of the tank on the i-mop and allow the tank to automatically snap into position. (Magnetic action will lock the Recovery Tank into place.) If in doubt, you can push the tank further into the seal for optimum vacuum.

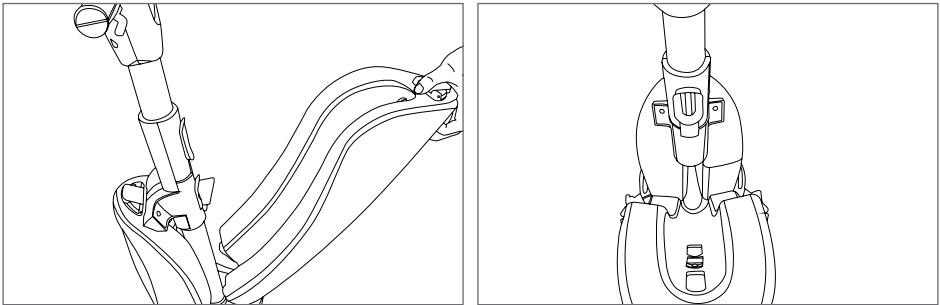

INSTALLING BATTERY PACKS

Hold the scrub deck of the i-mop with one hand, and with your other hand, slide the battery packs in from each side until you hear a loud click (blue into blue port, grey into grey port).

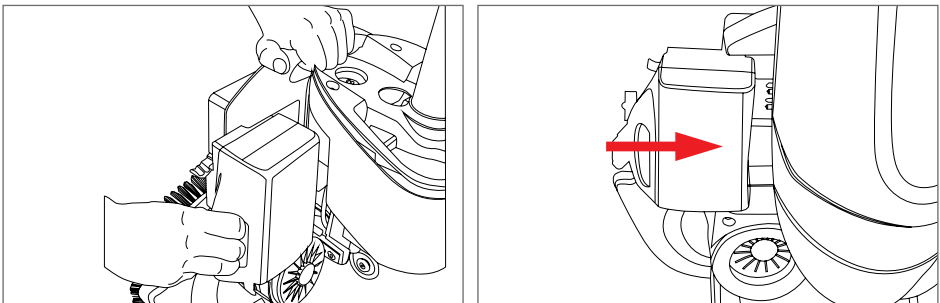

OPERATION

Read and understand the Safety Instructions section of this manual before operating the i-mop.

Filling the Solution Tank

Always fill the i-mop tank with clean water maximum 5L (1.25 gallon) from a tap or hose. To prevent dirt from entering the Solution Tank, use only non-foaming detergent.

Recovery Tank

Make sure the fluid level of the Recovery Tank does not exceed 8L (2 gallon) to prevent damage to the i-mop.

Note: Every time the Solution Tank is refilled, the Recovery Tank should also be emptied.

Setting the i-mop in the "Operating Position"

Crouch down and while holding the scrub deck with one hand, push the handle forward with the other hand. Bring the scrub deck slowly down to the floor.

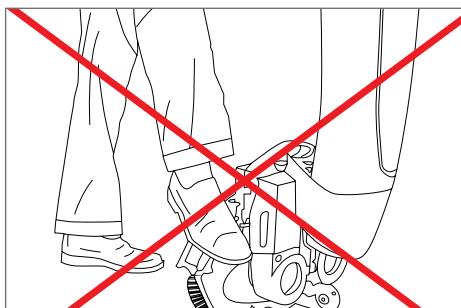
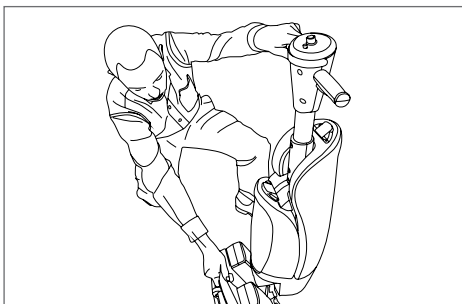

Never use your foot to lower the scrub deck to the floor.

ATTENTION: If the i-mop is in operating position, you will always need to hold it with at least one hand as the i-mop is not designed to stand without support.

Selecting the Mode of Operation

Choose the preferred mode on the i-mop operating panel:

MODE 1: Brush + Water/Solution

MODE 2: Brush (use the Brush only mode if the floor is very wet or to scrub stains)

MODE 3: Brush + Dry Vacuum

MODE 4: Brush + Water/Solution + Dry Vacuum

OFF

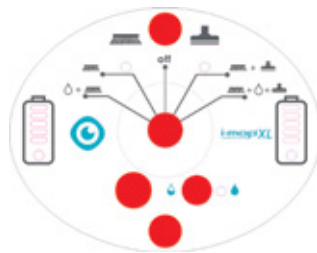

ECO (Water Saving Mode)

If you press the ECO water saving mode button once, the i-mop will use 40% less water until the ECO mode button is pressed again to turn off.

Battery Packs Status Indicator

Next to the mode switch are battery packs status indicators. When the battery indicator is red, it means that you are running out of battery power and have approximately 5 minutes left to operate the i-mop.

Controlling the i-mop

Stand behind the i-mop and hold the handle with one or two hands. Once the trigger on the i-mop handle is squeezed, the i-mop will move forward. Simply walk behind it. In case of emergency, just release the trigger. The i-mop brushes will stop immediately, and the vacuum motor will stop in about 3 seconds.

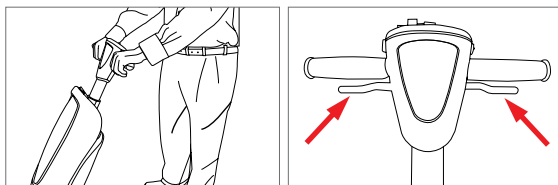

The key to optimally using the i-mop is to understand its ability to swivel!

Operating the i-mop is very intuitive and similar to steering a bicycle. The i-mop is designed to move forward. To turn, stop walking and use your inside hand* to turn the handle in the direction you want to go. The i-mop can swivel 360 degrees. You can reverse direction – simply swing around with it and follow in the new direction.

*When turning left, your "inside hand" is your left one. When turning right, your "inside hand" is your right one.

ATTENTION: Do not use the i-mop at an angle greater than arm's length because depressing more than 45 degrees can cause water to get in the vacuum motor.

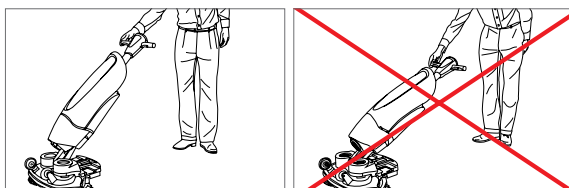

The i-mop scrub deck is designed to get as close as possible to walls. Approach walls diagonally with the edge of the i-mop and continue along the wall.

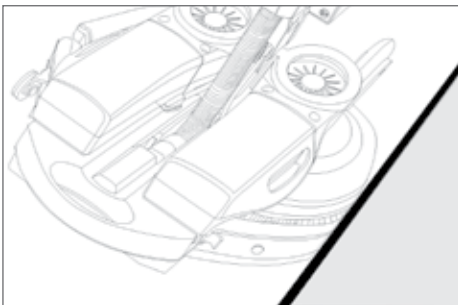

Switching Off/Completing Cleaning

Before you finish, switch the i-mop in the 3 “Brush + Dry” mode and operate it about 5-6 meters (15-20 ft) farther to vacuum up remaining solution. Then set the knob to the “OFF” position. Note that the vacuum motor will continue to run for approximately 3 more seconds.

Emptying Tanks

Dispose water or solution from both tanks in an appropriate drain. To clean the Recovery Tank thoroughly, partially fill it with fresh water and hold it horizontally with the holes facing up. Tilt the tank repeatedly, thoroughly rinsing all of the dirt and debris from the tank.

Note: Leave both caps off tanks to allow air flow throughout tanks. Every time the Solution Tank is refilled, the Recovery Tank should be emptied too.



WARNING

Please observe the local provisions regarding solution disposal related to wastewater treatment.

Removing Battery Packs

Put the i-mop in the “Park” position and stabilize it with one hand by holding it at the scrub deck. While pressing both plastic pins inwards, pull each battery pack.

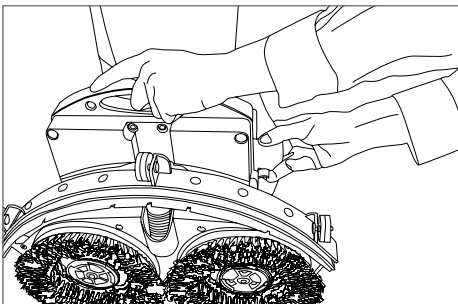
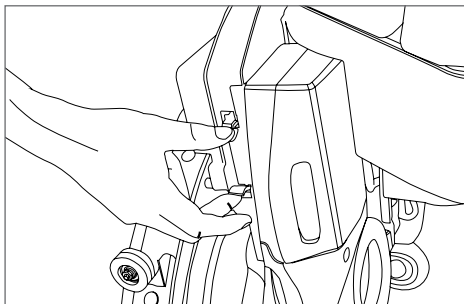

Transporting/Moving the i-mop Inside a Building

To move the i-mop from one location to another one in a building, put the i-mop in the “Park” position (described earlier). Hold the handle with one hand, and with the other hand, guide the scrub deck in the direction of the two transport wheels. Walk slowly and pay extra attention if you pull the i-mop over edges or barriers.



If you would like to load the i-mop into a vehicle or lift it over obstacles, always use two hands. With one hand, hold the pole/handle, and with the other hand, lift the scrub deck.

Note: Make sure the i-mop is transported horizontally and that both tanks (Solution Tank and Recovery Tank) are empty.

Transporting/Moving the i-mop Outside of a Building

To move the i-mop to locations outside of a building, we advise putting the i-mop in the “Park” position (described earlier). Always carry it with two hands inside the building before using the transport wheels.

Note: In order to decrease the weight of the i-mop, leave both tanks and battery packs off.

Transport the i-mop in a Car

Before loading the i-mop into a car, make sure both tanks and battery packs are removed. Put the i-mop in the “Park” position and lift the i-mop with two hands into a horizontal position. Prevent the i-mop from moving around during driving by using a tension belt or another appropriate restraint.



CAUTION

To prevent risk of injury and damage be mindful of the weight of the i-mop when you transport it.

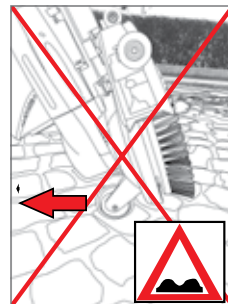
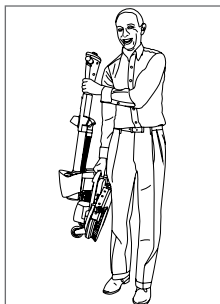

Storing the i-mop

- Always store the i-mop in the “Park” position.
- Be sure to flush the tanks out completely. To thoroughly flush out any solution in the lines and valves, refill Solution Tank with 0.5 to 1 liter (16-32 oz) of clean water and run the i-mop until the tank is empty.
- If the i-mop isn't used regularly, store the charged battery packs in a dry, clean place. Make sure the battery packs are charged monthly.

MAINTENANCE AND CARE

After Each Use

- Drain and rinse tanks with fresh water.
- Wipe the Recovery Tank with fresh water and a clean, damp cloth.
- Recharge the battery packs if needed.
- Check to see if both brushes are clean and intact. Clean them under fresh water or replace them if necessary.
- Replace brushes if yellow wear indicator is same height as other bristles.
- Check to see if the squeegee is clean and intact. Clean it with fresh water and wipe it with a clean, damp cloth or replace the squeegee blades if necessary between replacements. If the squeegee blade is worn, you can rotate it.

Weekly

Clean the exterior of the i-mop with a non-abrasive, non-solvent cleaner or a clean, damp cloth. To clean the scrub deck remove the brushes, then use a non-abrasive, non-solvent cleaner or a clean, damp cloth.

Accessories/Spare Parts

Only use accessories and spare parts which approved by the manufacturer. The exclusive use of original accessories and original spare parts ensures that the i-mop can be operated safely and in a trouble-free manner.

For information on accessories and spare parts see page 18, “Accessories and Spare Parts” section.

How to Replace the Brushes

With the i-mop in the “Park” position, hold the scrub deck with one hand while using your other hand to turn the left brush counterclockwise and the right brush clockwise until you feel resistance or see the motor disc turning as well. Pull the brushes off the motor disc toward you.

Visually inspect the motor disc and clean the i-mop scrub deck with a clean, dry cloth before you install the brushes.

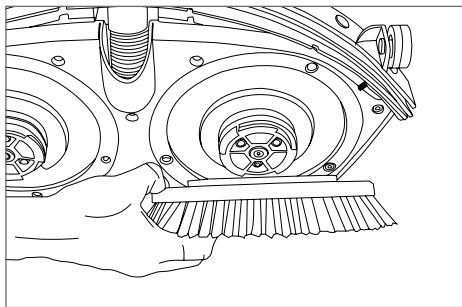
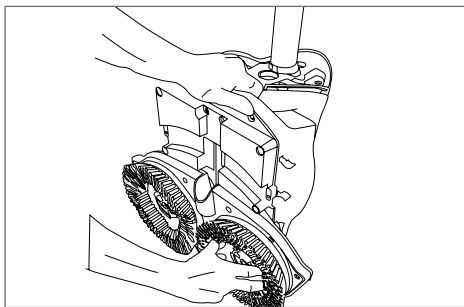

How to Replace the Squeegee

With the i-mop in the "Park" position, hold the scrub deck with one hand while pulling the left side of the squeegee off with the other hand. Switch hands afterwards and repeat for the right side. Detach the vacuum hose by twisting a 1/4 turn at the connector until the squeegee is loosened. Inspect the hose before you continue to install the new squeegee.

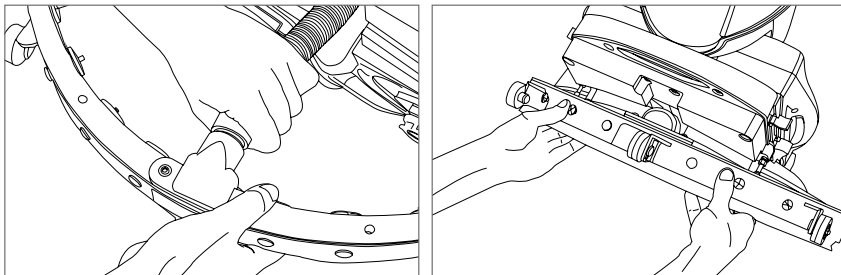

How to Switch or Replace the Squeegee Blades

Unscrew the 8 plastic nuts and take off the squeegee rear plate. Once the plastic part is removed, you can easily take off the front rubber blade. Push through the 8 screws in order to remove the squeegee front plate. Now you can also switch or replace the rear rubber blade. To assemble the squeegee again, reverse the previous instructions.

How to Replace the Vacuum Hose

After you detach the squeegee as written above and have removed the Solution Tank, you can see where the vacuum hose is connected at the i-mop handle. Hold the scrub deck with one hand, while detaching the vacuum hose by twisting a 1/4 turn at the connector until the squeegee is loosened. Now you can carefully pull the vacuum hose out of the machine.

Guide the new vacuum hose via the opening to the hose connector located at the i-mop handle. Connect them by twisting the hose a 1/4 turn at the connector until they have lined up, and reinstall the squeegee.

HOW TO RESET THE i-mop

Make sure the knob on the i-mop operating panel is in the "OFF" position before you slide out both battery packs. Hold the ECO Water Saving mode button for 30 seconds, reinstall both battery packs.

TROUBLESHOOTING AND SERVICE

Troubleshooting

No power – i-mop won't start

- Check if battery packs are fully charged.
- Ensure battery packs are properly installed.
- Remove and reinstall the battery packs and turn the i-mop on.
- Switch off and turn it on again.
- Reset the i-mop.

Insufficient Water Flow/No Water Flow

- Ensure the Solution Tank is filled.
- Check if the Solution Tank is sitting in proper position.
- Ensure water pipe isn't blocked.
- Ensure the Solution Tank has no dirt particles in it, and the filter is clean.
- Ensure you choose the correct operating mode.

Poor Water Recovery

- Check the function of the suction motor.
- Inspect vacuum hose for any objects obstructing the airflow.
- Ensure the squeegee opening is not blocked.
- Inspect yellow filter and clean if necessary.
- Inspect nose deflector and clean if necessary.
- Ensure squeegee blades are in order and intact.
- Check if the Recovery Tank is full. If so, empty it.
- Make sure the Recovery Tank is in the proper position.
- Make sure that the Recovery Tank lid is securely fitted.

Trouble Attaching Squeegee

- Ensure hose is pulled up into proper position.







TECHNICAL DATA

	METRIC	IMPERIAL
BOX DIMENSIONS (L X W X H)	33cm x 64cm x 124cm	13" x 25" x 49"
TOTAL WEIGHT BOX (INCLUDING BATTERY PACKS)	40.2 kg	88.6 lbs
SOLUTION TANK	5L	1.2 Gal
RECOVERY TANK*	8L maximum	2 Gal maximum
WORKING WIDTH	62cm	24.4"
BRUSH PRESSURE	29 kg	64 lbs
BRUSH SPEED	350 rpm	350 rpm
MOTOR (VACUUM)	24V/180W	24V/180W
MOTOR (BRUSH)	24V/170W (each motor)	24V/170W (each motor)
INPUT VOLTAGE (BATTERY CHARGER)	110 – 240V AC	110 – 240V AC
OPERATING VOLTAGE	24V DC	24V DC
BATTERY PACK Lithium-ion (Li-ion)	24V, 14AH, 353WH	24V, 14AH, 353WH
OPERATING TIME	60 minutes	60 minutes

* Always install an empty Recovery Tank whenever a new Solution Tank is installed.

ACCESSORIES AND SPARE PARTS

ITEM		P/N	DESCRIPTION
1		K.1.72.0000.0R	Brush Motor (left)
2		K.1.72.0000.1R	Brush Motor (right)
3		K.1.S.72.0074.357BSRA	Battery Pack (left)
4		K.1.S.72.0079.357BSRA	Battery Pack (right)
5		K.1.S.72.0026.4	Magnetic Valve
6		K.1.5.72.0094.0	Stretch Hose
7		K.1.S.72.1096.0	Squeegee Complete

ITEM		P/N	DESCRIPTION
8		K.10.72.1100.0	Rear Rubber Squeegee
9		K.10.72.1099.0	Front Rubber Squeegee
10		K.1.S.72.1081.0	Solution Tank
11		K.1.S.72.1088.0	Recovery Tank
12		K.2.S.72.1092.797/797	Brush Set
13		K.1.72.0035.0	Vacuum Motor

ENVIRONMENTAL PROTECTION



The packaging materials can be recycled. Please do not throw the packaging material into household waste. Please recycle it.

Old devices contain valuable materials that can be recycled.



Rechargeable battery packs contain materials that should not be disposed of in landfills. Please dispose of old devices and battery packs and that they must be disposed of through suitable waste collection systems.

CE DECLARATION

We hereby declare that the machine described below complies with the relevant basic safety and health requirements of the EU Directives, both in its basic design and construction as well as in the version put into circulation by us. This declaration shall cease to be valid if the machine is modified without our prior approval.

Declaration Of Conformity

EG/EC KONFORMITÄTSERKLÄRUNG DECLARATION OF CONFORMITY Wir We Future Cleaning Technologies B.V., Hoppenkuijl 27b, 5626 DD Eindhoven	
Erklären in alleiniger Verantwortung, dass das Produkt Declare under our sole responsibility that the product	Scheuersaugmaschine Scrubber-dryer
i-Mop Battery Charger (Art der Maschine / Type of machine)	
S.72.0299.0 und folgende / and following (Modell – Seriennummer; Baujahr / model – serial number; year of production)	
auf das sich diese Erklärung bezieht, mit den folgenden Normen übereinstimmt, to which this declaration relates is in conformity with the following standards,	
CB report issue base on IEC 60335-2-29:2002 +A1 +A2 IEC 60255-1 ; 2010 +A1	
2014/30/EU Electromagnetic Compatibility 2014/35/EU Low Voltage Directive EMC EN55022:2010+AC:2011 EN55024:2010 EN61000-3-2:2014 EN61000-3-3:2013 LVD EN60335-1:2012/A11:2014 EN60335-2-29:2004/A2:2010 EN62233:2008	
(Titel und/oder Nummer sowie Ausgabedatum der Norm(en) oder der anderen normativen Dokument(e) (Title and/or number and data of issue of the standard(s) or other normative documents(s))	
gemäß den Bestimmungen der Richtlinien: follow the provision of directives:	
Eindhoven, 01.03.2017 (Ort und Datum der Ausstellung) (Place and Date of issue)	 Frank van de Ven Director (Name und Unterschrift oder gleichwertige Kennzeichnung des Beteiligten) (name and signature or equivalent marking or authorized person)

WARRANTY

The warranty terms published by our i-partners are applicable in their respective countries. Please register your i-mop to ensure that we will repair potential failures of your accessory within the warranty period free of charge, provided that such failure to caused by faulty material or defects in fabrication. In the event of a warranty claim, please contact your dealer or the nearest authorized Customer Service Center. Please submit proof of purchase.

EXPLODED VIEW

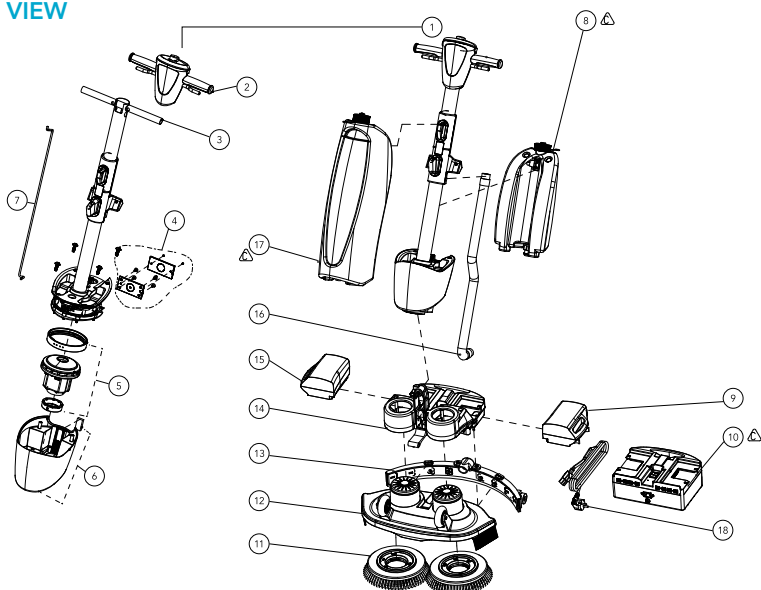

ITEM	P/N	DESCRIPTION	QTY
1	K.1.TU.IMOPXXL.230.2/797	ASSEMBLY TOP UNIT	1
2	K.1.S.72.1059.2/797	ASSEMBLY CONTROL UNIT	1
3	K.1.S.72.1040.0	ASSEMBLY INLET TUBE	1
4	K.1.S.72.0031.2A	HINGE WELDING ASSEMBLY TOP UNIT KIT	1
5	K.1.S.72.0035.0	VACUUM MOTOR KIT	1
6	K.1.S.72.0111.357	MOTOR UNIT COVER KIT	1
7	K.1.S.72.0039.0/B	UTP CABLE RJ 45 L 100 CM	1
8	K.1.S.72.1081.1	ASSEMBLY SOLUTION TANK COMPLETE	1
9	K.1.S.72.0074.357BSRA	ASSEMBLY BATTERY PACK BLUE [LEFT]	1
10	K.1.S.72.0299.0	i-mop BATTERY MCU CHARGER	1
11	K.2.S.72.1092.797/797	ASSEMBLY BRUSH i-mop COMPLETE BLUE BRISTLE I BLUE LOCKER	2
12	K.1.S.72.1059.2/797	ASSEMBLY BRUSH UNIT i-mop 24V	1
13	K.1.S.72.1096.0	SQUEEGEE ASSEMBLY	1
14	K.1.S.72.1065.2	ASSEMBLY MAIN LEVER UNIT	1
15	K.1.S.72.0079.2BSRA	ASSEMBLY BATTERY PACK GREY [RIGHT]	1
16	K.1.S.72.0094.0	STRETCH HOSE COMPLETE	1
17	K.1.S.72.1088.1	RECOVERY TANK	1
18	K.1.72.0152.0	POWER CORD EUR	1
	K.1.72.0152.3	POWER CORD UK	
	K.1.72.0152.2	POWER CORD SWISS	
	K.1.72.0152.1	POWER CORD 115V	

YOUR LOCAL i-partner



Future Cleaning Technologies (FCT) B.V.
 Hoppenkuil 27b, 5626 DD Eindhoven
 The Netherlands
www.i-teamglobal.com